

ROPE LIGHT | STRIP LIGHT | POWER SUPPLY

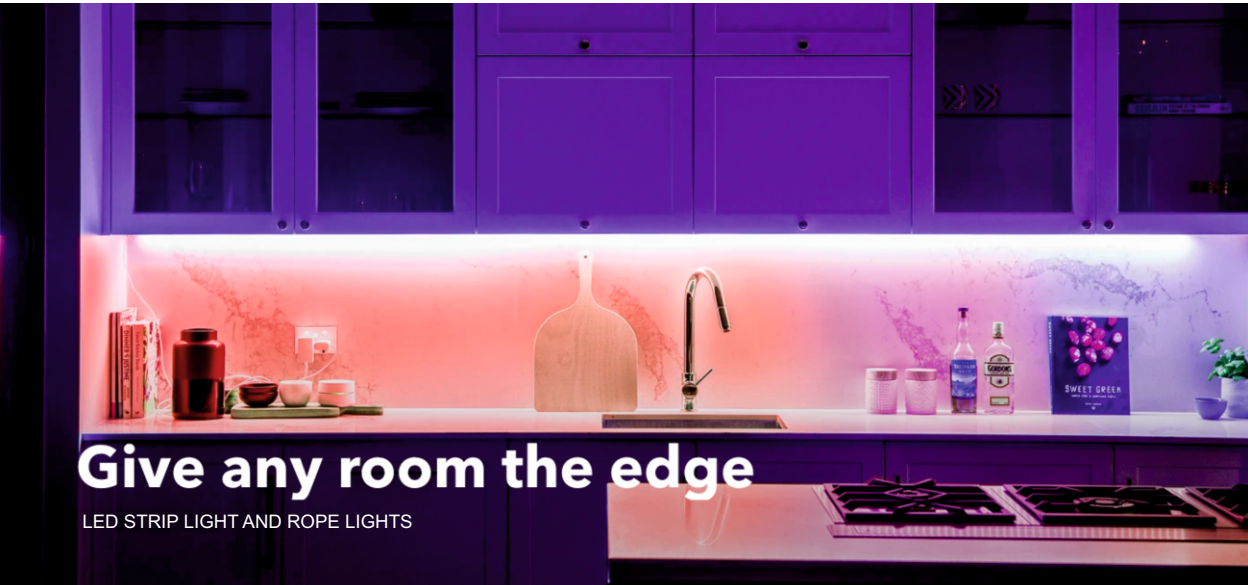

MODERN LED STRIP LIGHTING FOR YOUR OEM AND BRANDING



Give any room the edge

LED STRIP LIGHT AND ROPE LIGHTS

We are Vensen, your one-stop shop for all your LED rope lights, strips, and drivers requirements.

Known for our high quality, we manufacture a vast variety of LED strips, rope light and drivers suited for all your projects. We work with one simple but effective formula: great quality products and speedy service. From relaxing warm white to vibrant RGB, our range includes 5mm, 8mm and 10mm available in both 12v and 24v. We also produce rope lights in 9 various colours including warm white, neutral white, white, red, green, blue, pink, Ice Blue and amber. With these we also manufacture drivers which

comes in three different series (Regular, Ultra, and Smart) ranging from 2Amp to 33Amp.

Many of our luminaries now have the CRI 90 colour rendering standard, creating a warm natural light that stimulates a harmonious atmosphere to enhance your inspired designs. We have a team of experts dedicated to helping our clients with their queries and giving them the best suggestions for their requirements. You will find a huge range of top-notch LED strips and drivers, all of which are guaranteed to save you money on your electricity bills.

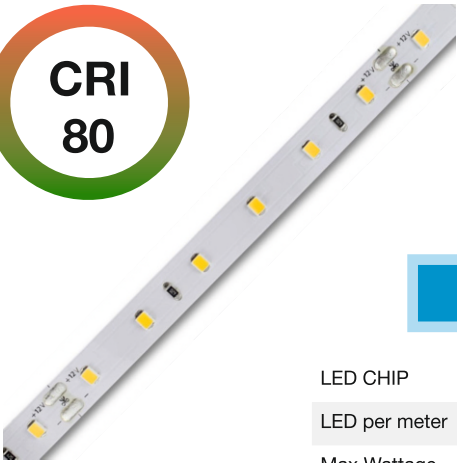
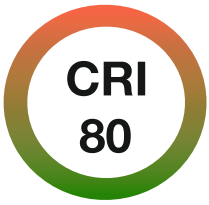

2835 | 60 LED | 12V DC

SUPER BRIGHT 4.8W/M
60 LED STRIP LIGHT

TECHNICAL SPECIFICATIONS

LED CHIP	2835
LED per meter	60
Max Wattage	4.8W/m
Voltage	12V DC
PCB Width	8MM
IP Rating	IP 20
Dimension	5 Mtrs
Colour Rendering Index	80/90 CRI
Beam Angle	120°
Colours	3K, 4K, 6K, Red,Green, Blue, Pink, Amber, Ice Blue

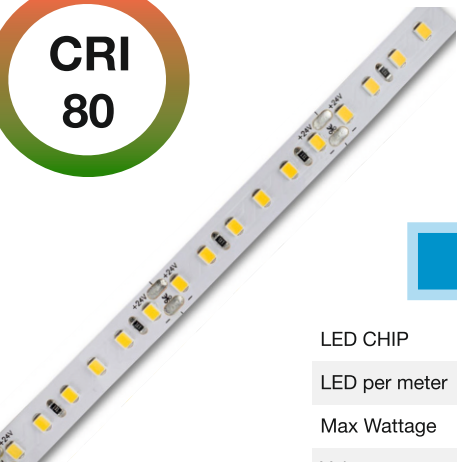
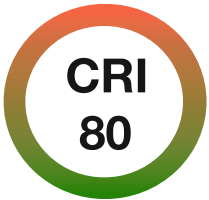

2835 | 120 LED | 12V/24V DC

SUPER BRIGHT 9W/M
120 LED STRIP LIGHT

TECHNICAL SPECIFICATIONS

LED CHIP	2835
LED per meter	120
Max Wattage	9W/m
Voltage	12V/24V DC
PCB Width	8MM
IP Rating	IP 20
Dimension	5 Mtrs
Colour Rendering Index	80/90 CRI
Beam Angle	120°
Colours	3K, 4K, 6K, Red,Green, Blue, Pink, Amber, Ice Blue

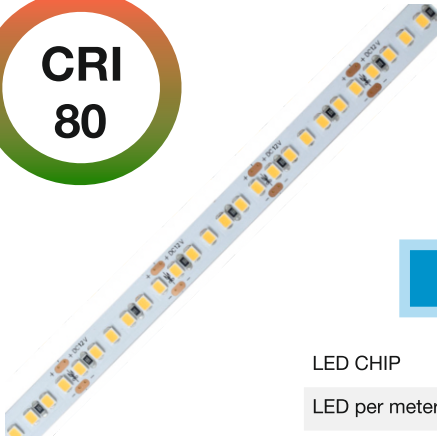
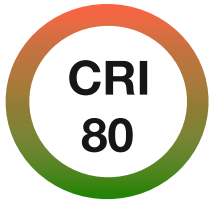

2835 | 180 LED | 12V DC

SUPER BRIGHT 14W/M
180 LED STRIP LIGHT

TECHNICAL SPECIFICATIONS

LED CHIP	2835
LED per meter	180
Max Wattage	14W/m
Voltage	12V DC
PCB Width	10MM
IP Rating	IP 20
Dimension	5 Mtrs
Colour Rendering Index	80/90 CRI
Beam Angle	120°
Colours	3K, 4K, 6K, Red,Green, Blue, Pink, Amber, Ice Blue

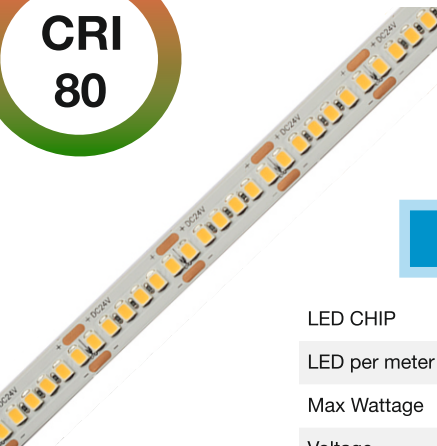
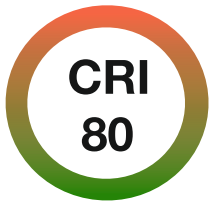

2835 | 240 LED | 12V/24V DC

SUPER BRIGHT 18W/M
240 LED STRIP LIGHT

TECHNICAL SPECIFICATIONS

LED CHIP	2835
LED per meter	240
Max Wattage	18W/m
Voltage	12V/24V DC
PCB Width	10MM
IP Rating	IP 20
Dimension	5 Mtrs
Colour Rendering Index	80/90 CRI
Beam Angle	120°
Colours	3K, 4K, 6K, Red,Green, Blue, Pink, Amber, Ice Blue

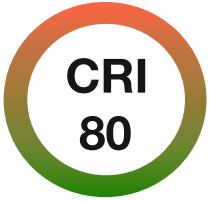

5050 | RGB | 60 LED | 12V DC

Multi Colour LED strip 13W/m

SUPER BRIGHT 13W/M 60 LED RGB STRIP LIGHT



TECHNICAL SPECIFICATIONS

LED CHIP	5050
LED per meter	60
Max Wattage	13W/m
Voltage	12V DC
PCB Width	10MM
IP Rating	IP 20
Dimension	5 Mtrs
Beam Angle	120°
Colours	Multi colours from RGB

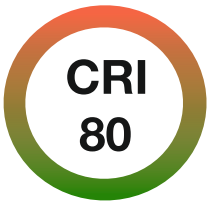

2835 | CCT | 120/180 LED | 12V/DC

TRI Colour LED strip 14W/m

SUPER BRIGHT 14W/M 180 LED 3in1 STRIP LIGHT

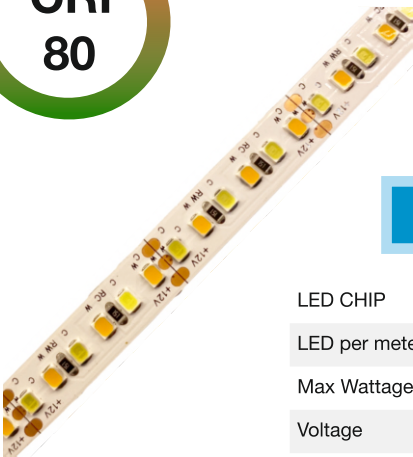

TECHNICAL SPECIFICATIONS

LED CHIP	2835
LED per meter	120L/180L
Max Wattage	14W/m
Voltage	12V/24V DC
PCB Width	10MM
IP Rating	IP 20
Dimension	5 Mtrs
Colour Rendering Index	80/90 CRI
Beam Angle	120°
Colours	3K, 4K, 6K

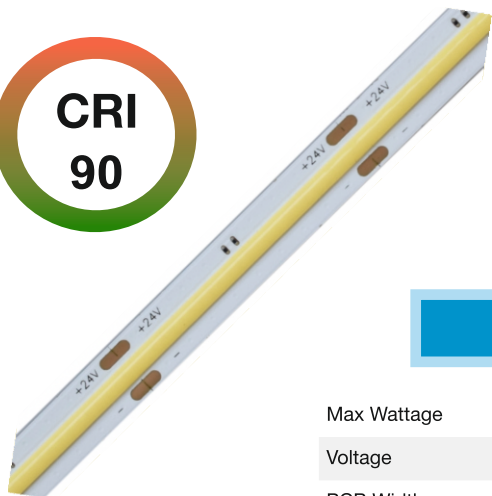
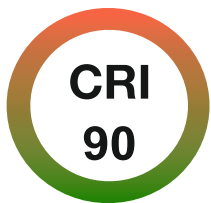

480 LED | COB | 24V DC

SUPER BRIGHT 12W/M
COB DOTLESS STRIP LIGHT

TECHNICAL SPECIFICATIONS

Max Wattage	12W/m
Voltage	24V DC
PCB Width	10MM
IP Rating	IP 20
Dimension	5 Mtrs
Beam Angle	120°
Colours	3K, 4K, 6K,

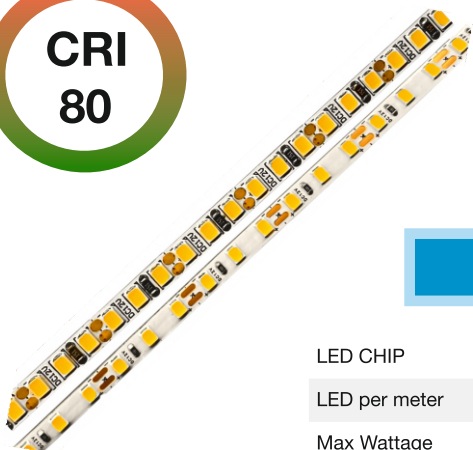
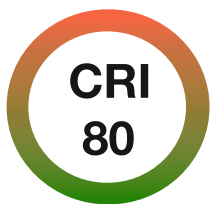

2835 | 5MM | 120/180 LED | 12V/24V DC

SUPER BRIGHT 9W/14W/M
120/180 LED 5mm STRIP LIGHT

TECHNICAL SPECIFICATIONS

LED CHIP	2835
LED per meter	120L/180L
Max Wattage	9W/14W/m
Voltage	12V/24V DC
PCB Width	5MM
IP Rating	IP 20
Dimension	5 Mtrs
Colour Rendering Index	80/90 CRI
Beam Angle	120°
Colours	3K, 4K, 6K

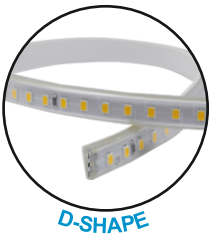
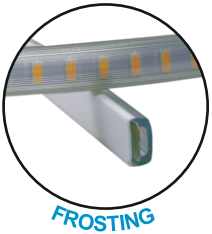
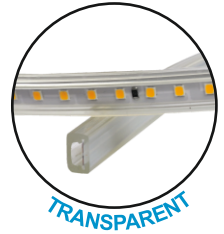
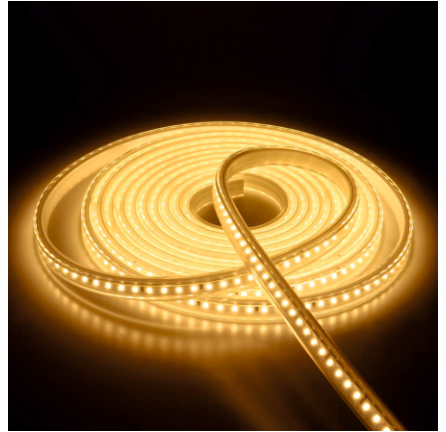
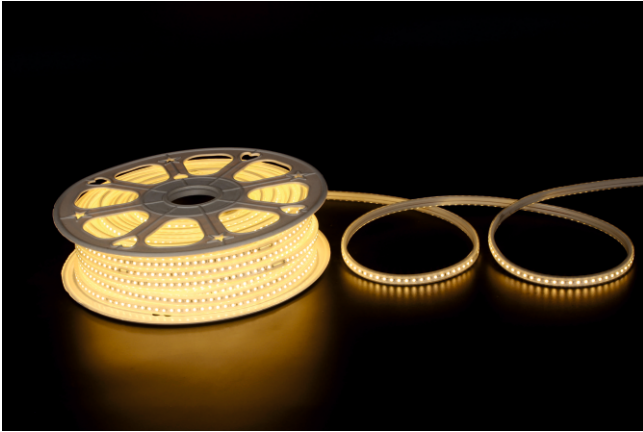

ROPE LIGHT | 60/120 LED | 220V/DC

Single Colour & RGB LED Rope Lights

**SUPER BRIGHT 9W/M
120LED STRIP LIGHT**

TECHNICAL SPECIFICATIONS

LED CHIP	2835
LED per meter	60L/120L
Voltage	220V DC
PCB Width	8MM
IP Rating	IP 65
Dimension	50 Mtrs
Colour Rendering Index	80/90 CRI
Beam Angle	120°
Colours	3K, 4K, 6K, Red, Green, Blue, Pink, Amber, Ice Blue

LED POWER SUPPLY SERIES



LED POWER SUPPLY

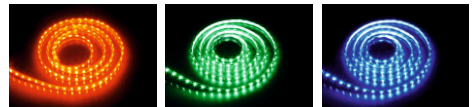

LED POWER SUPPLY

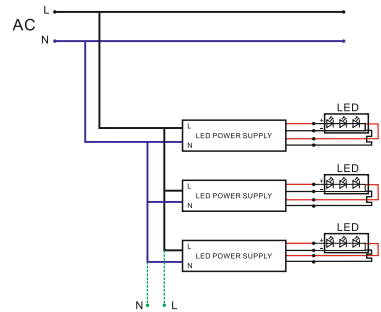
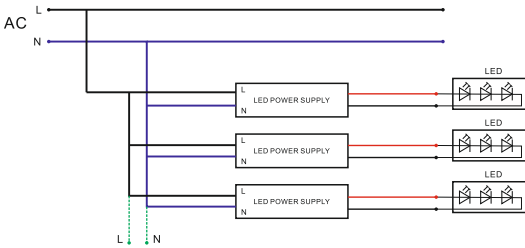

SMART SLIM SERIES

ITEM NO.	Size (MM)	Input Voltage (V)	Output Voltage (V)	Output Current (A)	Output Power (W)
VS-W36	135*35*23	100-265V	12V	3A	36W
VS-W60	172*34*23	100-265V	12V	5A	60W
VS-W120	145*49*29	100-265V	12V	10A	120W
VS-W60	172*34*23	100-265V	24V	2.5A	60W
VS-W120	145*49*29	100-265V	24V	5A	120W
VS-W200	195*48*29	185-265V	24V	8.3A	200W

ULTRA SLIM

SERIES

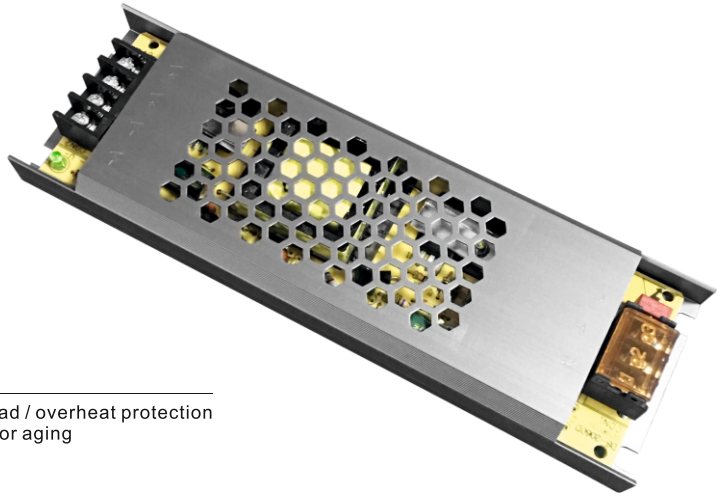

PRODUCT FEATURES

- Built in short circuit / over-voltage overload / overheat protection
- 100% full load high temperature burning or aging
- Air natural convection cooling
- Working temp: -30°C~50°C
- Storage temp: -40°C~80°C
- Time between failures: >50000h

ITEM NO.	Size (MM)	Input Voltage (V)	Output Voltage (V)	Output Current (A)	Output Power (W)
VS-T60	150*53*22	176-264V	12V	5A	60W
VS-T100	195*53*22	176-264V	12V	8.3A	100W
VS-T120	226*53*22	176-264V	12V	10A	120W
VS-T150	250*53*22	176-264V	12V	12.5A	150W
VS-T200	282*53*22	176-264V	12V	16.5A	200W
VS-T300	308*53*22	176-264V	12V	25A	300W
VS-T333	308*53*22	176-264V	12V	33A	400W

REGULAR SLIM

SERIES



PRODUCT FEATURES

- Built in short circuit / over-voltage overload / overheat protection
- 100% full load high temperature burning or aging
- Air natural convection cooling
- Working temp: -30°C~50°C
- Storage temp: -40°C~80°C
- Time between failures: >50000h

ITEM NO.	Size (MM)	Input Voltage (V)	Output Voltage (V)	Output Current (A)	Output Power (W)
VS-E25	103*30*21	100-265V	12V	2A	24W
VS-E36	103*30*21	100-265V	12V	3A	36W
VS-E60	160*40*31	100-265V	12V	5A	60W
VS-E120	188*46*35	100-265V	12V	10A	120W
VS-E150	213*60*40	185-265V	12V	12.5A	150W
VS-E200	223*68*40	185-265V	12V	16.5A	200W
VS-E360	223*69*40	185-265V	12V	30A	360W



OUR SERVICES

OEM SERVICES (Branding and Printing)

We provide on demand OEM customised services. We design printed PCB, special CCT, branded packaging and high CRI according to your brand.



Shipment

We provide fast and reliable shipment for your manufactured good. *

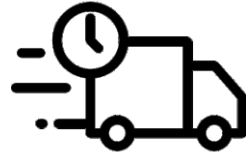

Technical Information

We can help you guide and answer all the questions you may have related to our products.



Small MOQ/Flexibility

Great business comes from small orders hence, we also accept small orders (T&C apply)



Lighting your brand
Lighting your life

Tel: +91 78498 25832/33/34
E: vensenlighting1@gmail.com
W: www.vensenlighting.com

VENSEN LIGHTING PVT. LTD.

G979B, G979C, 3rd Phase, Sitapura Industrial Area, near Balaji market,
Jaipur, Rajasthan